

FREESTANDING ALUMINUM TOWER MODEL #7-50

TOTAL WEIGHT: 118 LBS.

WIND LOADING:

80 mph	7.0 Sq. Ft.
100 mph	4.0 Sq. Ft.
110 mph	2.5 Sq. Ft.

Contact Universal Towers to confirm
geographical location of your tower and
all wind load implications

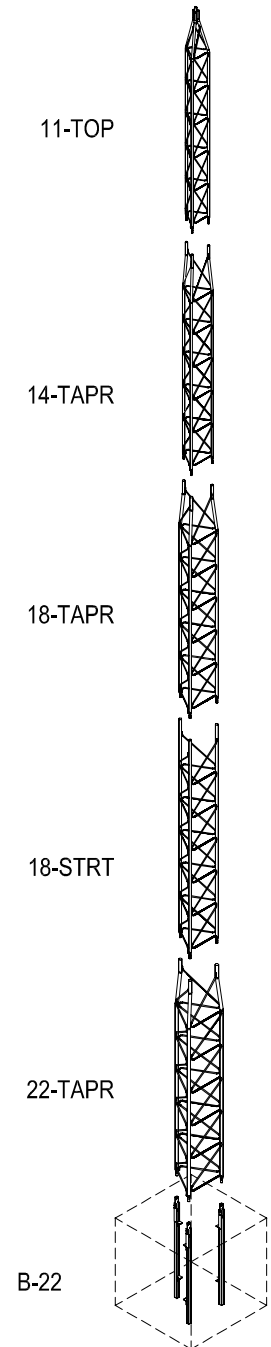
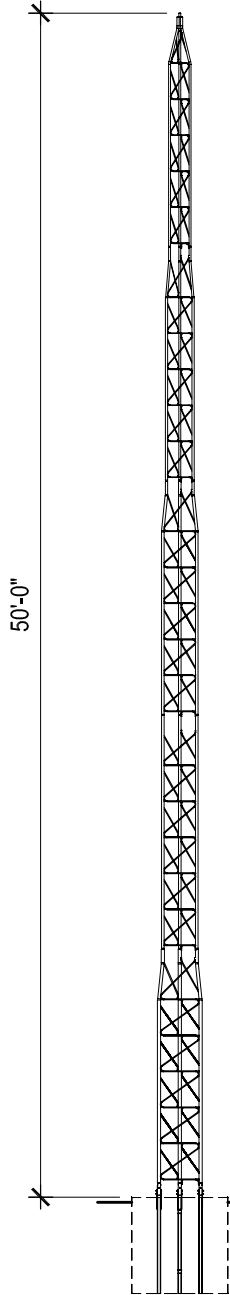

WARRANTY

UNIVERSAL TOWERS ARE WARRANTED AGAINST DEFECTIVE MATERIAL OR WORKMANSHIP AND ARE SUBJECT TO REPAIR OR TO MATERIAL REPLACEMENT ONLY IF FAILURE RESULTS FROM THESE FACTORS WITHIN ONE YEAR FROM PURCHASE BY USER. THIS WARRANTY DOES NOT EXTEND TO ANY OF OUR PRODUCTS WHICH HAVE BEEN SUBJECTED TO MISUSE, NEGLIGENCE, ACCIDENT, IMPROPER INSTALLATION OR APPLICATION, NOR SHALL IT EXTEND TO UNITS WHICH HAVE BEEN REPAIRED OR SUBSTANTIALLY ALTERED OUTSIDE OF OUR FACTORY. THIS WARRANTY IS IN LIEU OF ALL OTHER WARRANTIES EXPRESSED OR IMPLIED.

ELEVATION	2
SCALE: 1/8"=1'=0"	

ISOMETRIC	1
SCALE: N.T.S.	

ALUMINUM TOWER



UNIVERSAL TOWERS
A DIVISION OF
UNIVERSAL MANUFACTURING CORP.
43900 GROESBECK HWY.
CLINTON TOWNSHIP, MI 48036
PH: (586) 463-2560
FAX: (586) 463-2964

JOB NO.:

COMPONENT:

7-50

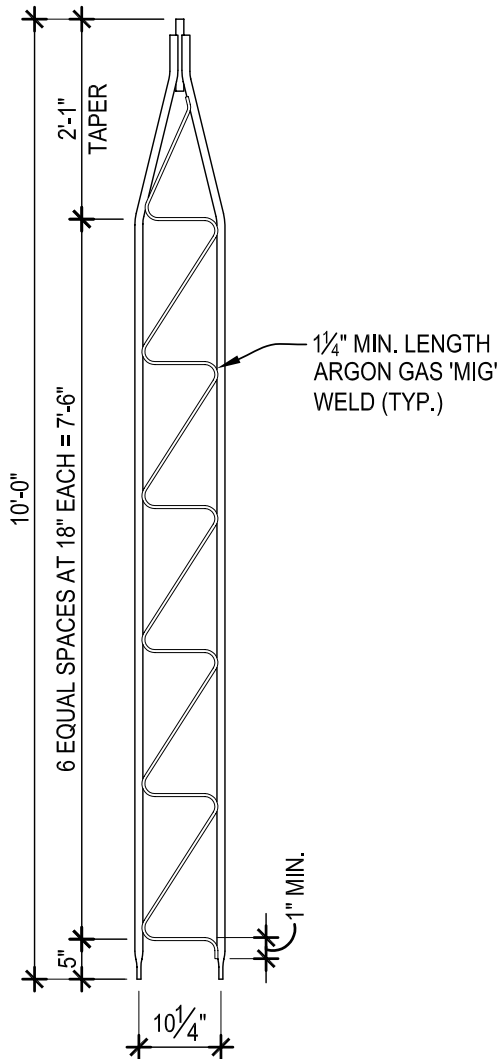

ELEVATION

SCALE: 1/2"=1'-0"

2

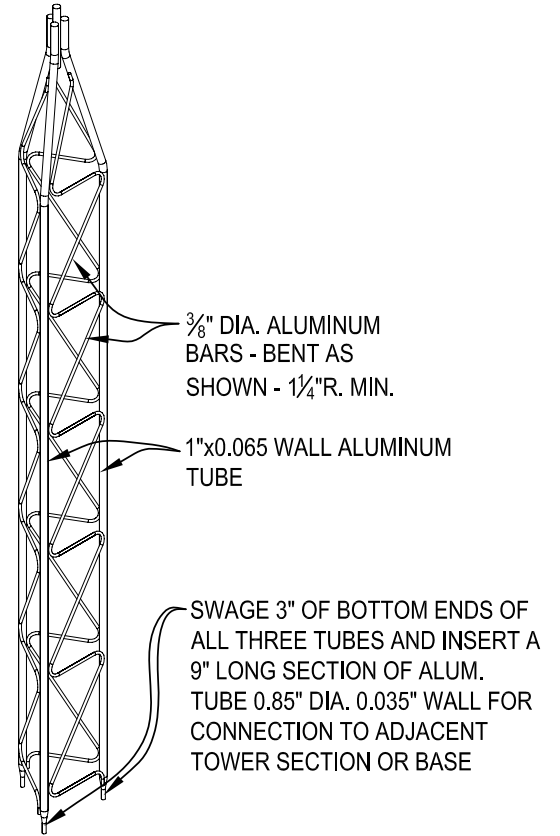

ISOMETRIC

SCALE: N.T.S.

3

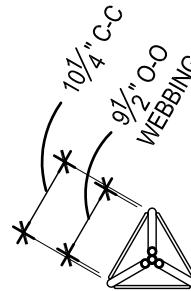

PLAN VIEW

SCALE: 1/2"=1'-0"

1

TOP SECTION



UNIVERSAL TOWERS
 A DIVISION OF
 UNIVERSAL MANUFACTURING CORP.
 43900 GROESBECK HWY.
 CLINTON TOWNSHIP, MI 48036
 PH: (586) 463-2560
 FAX: (586) 463-2964

JOB NO.:

COMPONENT:

11-TOP

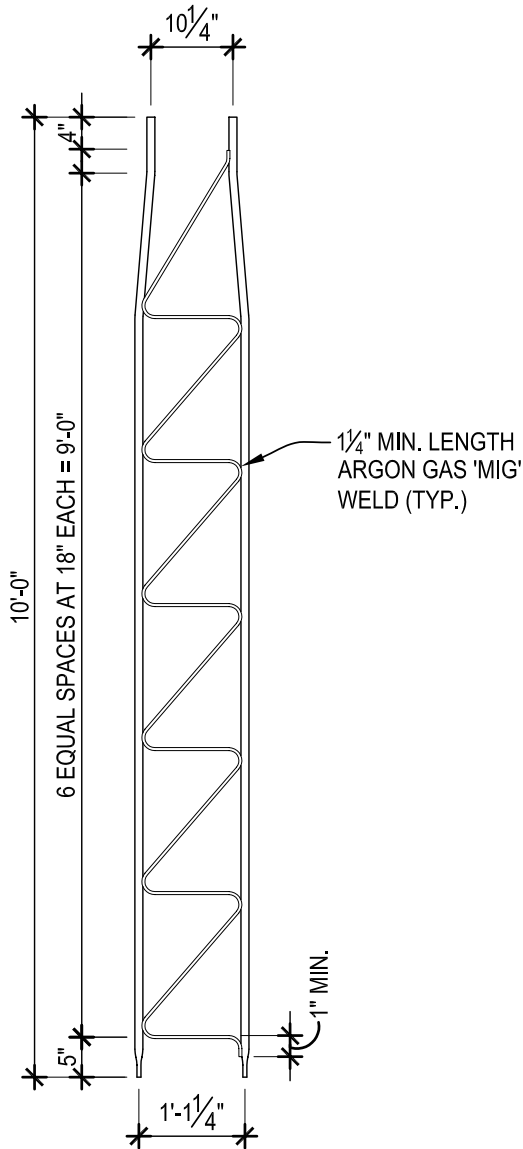

ELEVATION

SCALE: 1/2"=1'-0"

2

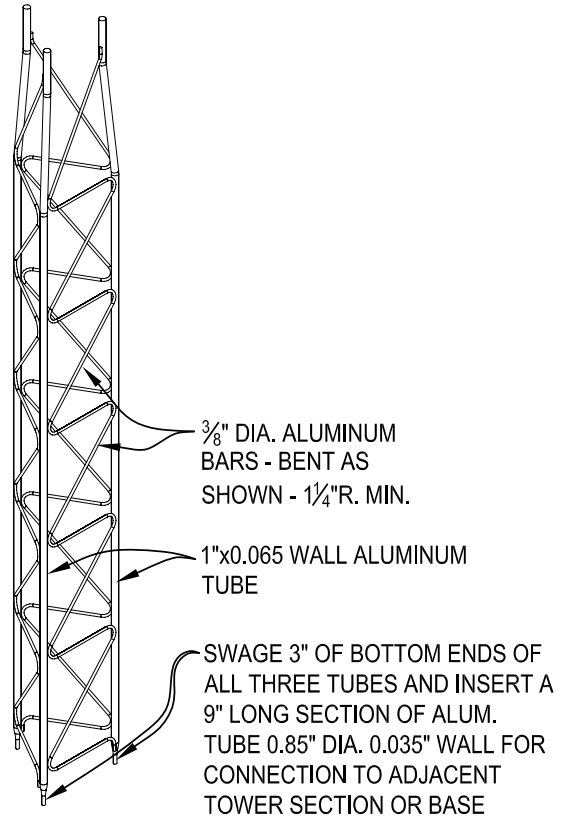

ISOMETRIC

SCALE: N.T.S.

3

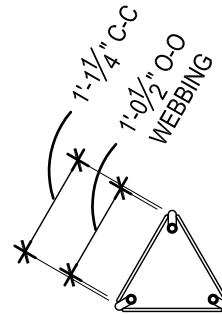

PLAN VIEW

SCALE: 1/2"=1'-0"

1

TAPERED SECTION



UNIVERSAL TOWERS
 A DIVISION OF
 UNIVERSAL MANUFACTURING CORP.
 43900 GROESBECK HWY.
 CLINTON TOWNSHIP, MI 48036
 PH: (586) 463-2560
 FAX: (586) 463-2964

JOB NO.:

COMPONENT:

14-TAPR

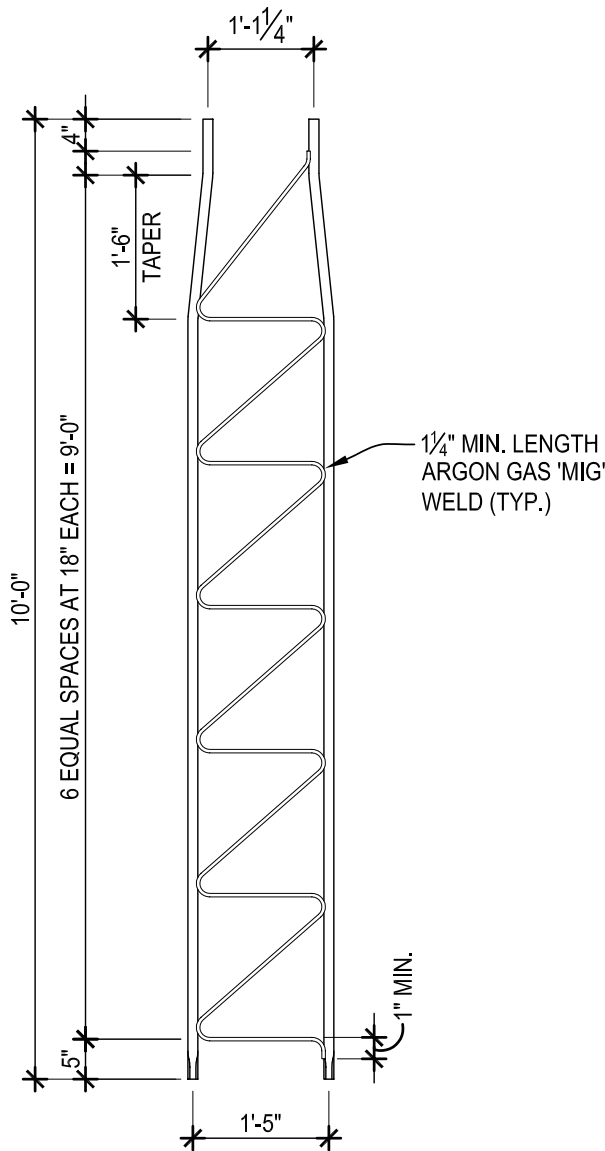

ELEVATION 2
SCALE: 1/2"=1'-0"

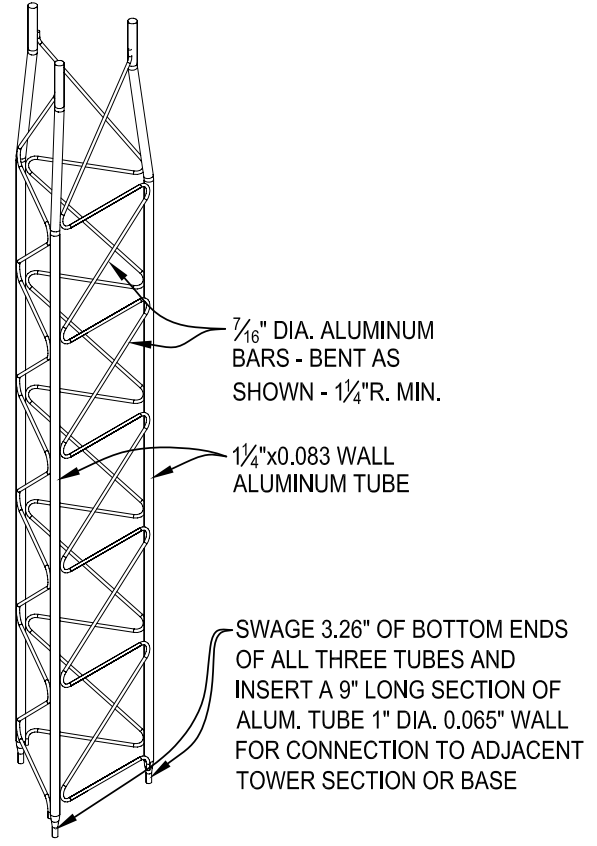

ISOMETRIC 3
SCALE: N.T.S.

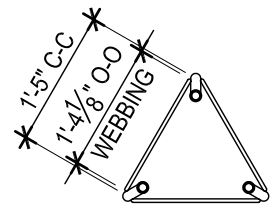

PLAN VIEW 1
SCALE: 1/2"=1'-0"

TAPERED SECTION

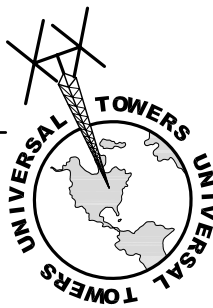

UNIVERSAL TOWERS
A DIVISION OF
UNIVERSAL MANUFACTURING CORP.
43900 GROESBECK HWY.
CLINTON TOWNSHIP, MI 48036
PH: (586) 463-2560
FAX: (586) 463-2964

JOB NO.:

COMPONENT:
18-TAPR

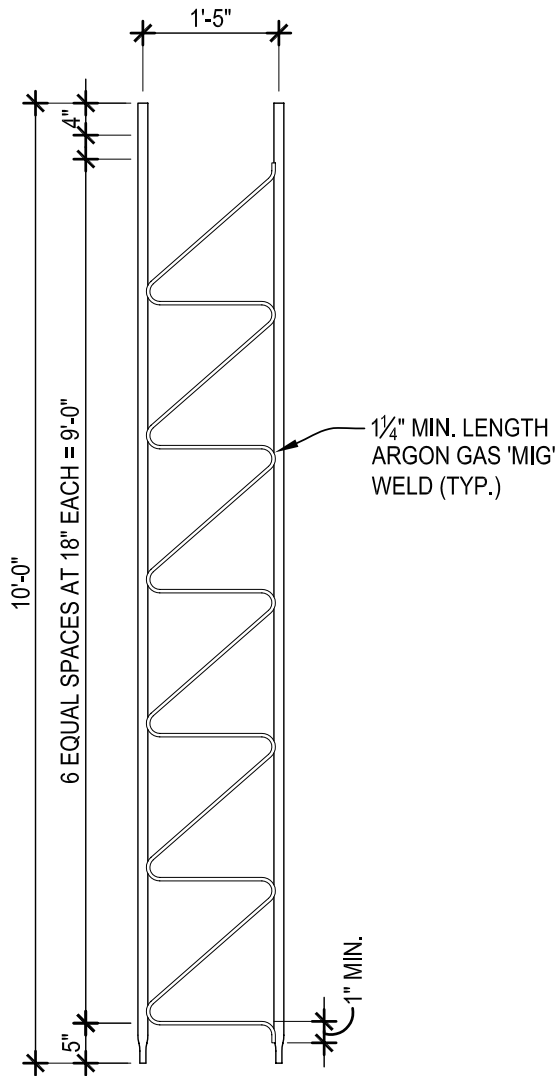

ELEVATION

SCALE: 1/2"=1'-0"

2

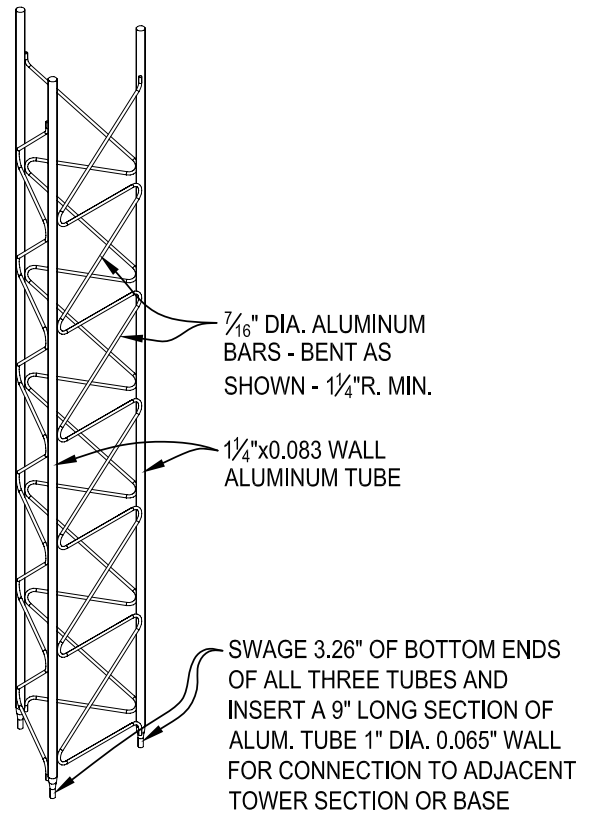

ISOMETRIC

SCALE: N.T.S.

3

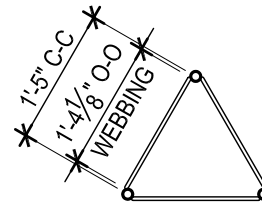

PLAN VIEW

SCALE: 1/2"=1'-0"

1

STRAIGHT SECTION



UNIVERSAL TOWERS
 A DIVISION OF
 UNIVERSAL MANUFACTURING CORP.
 43900 GROESBECK HWY.
 CLINTON TOWNSHIP, MI 48036
 PH: (586) 463-2560
 FAX: (586) 463-2964

JOB NO.:

COMPONENT:

18-STRT

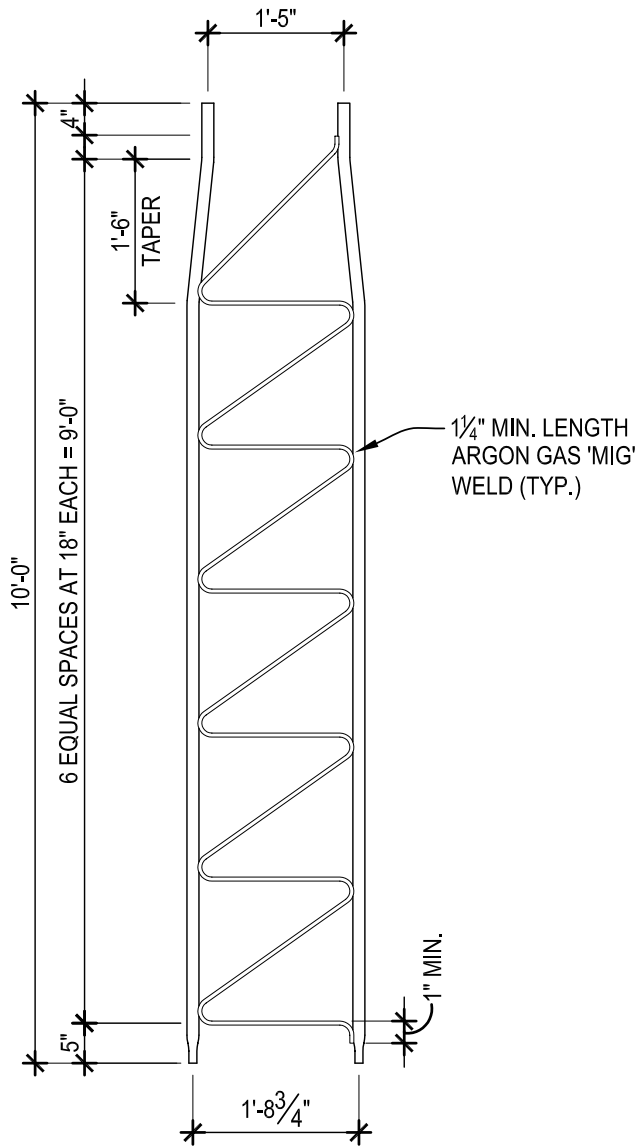

ELEVATION 2

SCALE: 1/2"=1'-0"

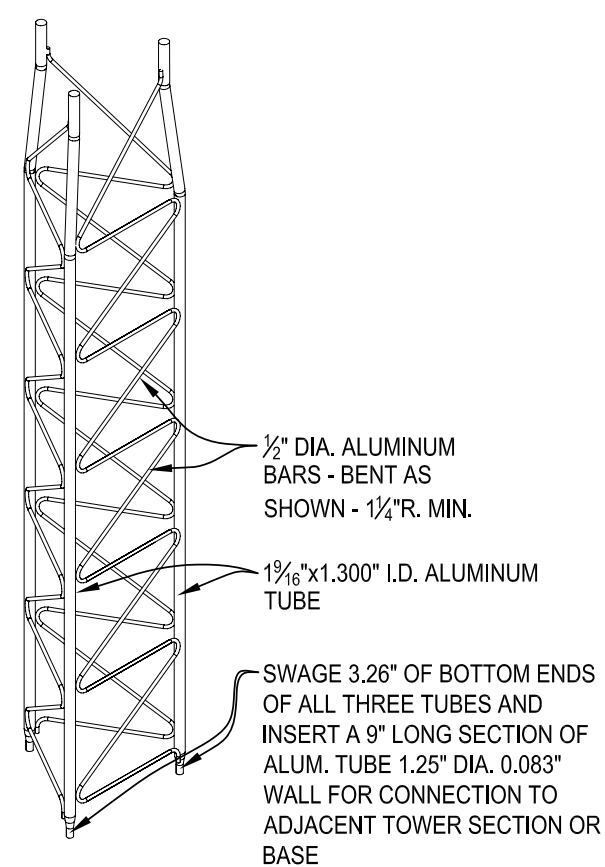

ISOMETRIC 3

SCALE: N.T.S.

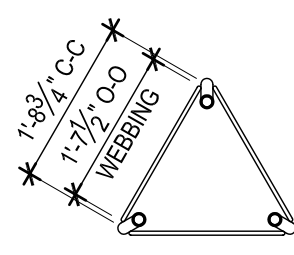

PLAN VIEW 1

SCALE: 1/2"=1'-0"

TAPERED SECTION



UNIVERSAL TOWERS
 A DIVISION OF
 UNIVERSAL MANUFACTURING CORP.
 43900 GROESBECK HWY.
 CLINTON TOWNSHIP, MI 48036
 PH: (586) 463-2560
 FAX: (586) 463-2964

JOB NO.:

COMPONENT:

22-TAPR

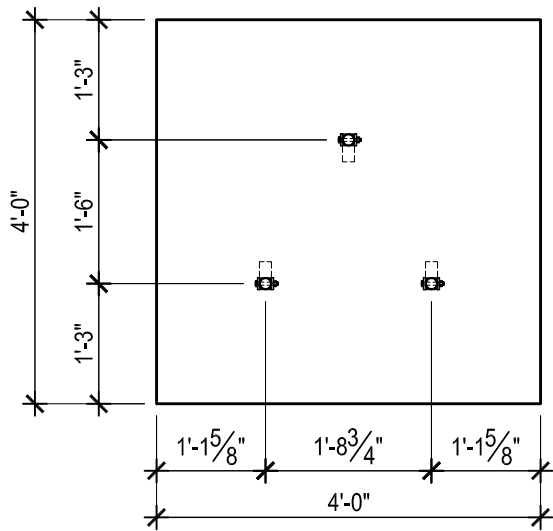

PLAN VIEW

SCALE: 1/2"=1'-0"

1

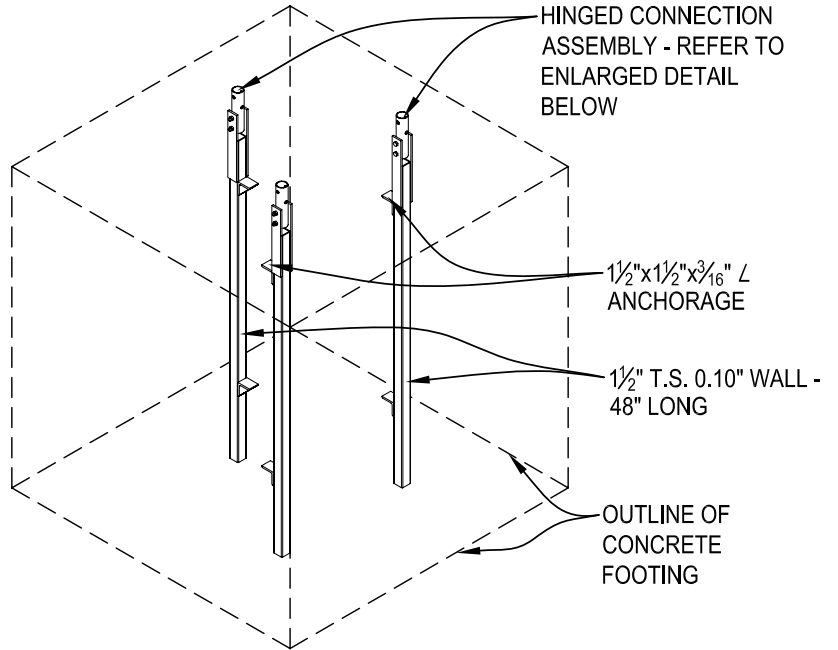

ISOMETRIC

SCALE: N.T.S.

3

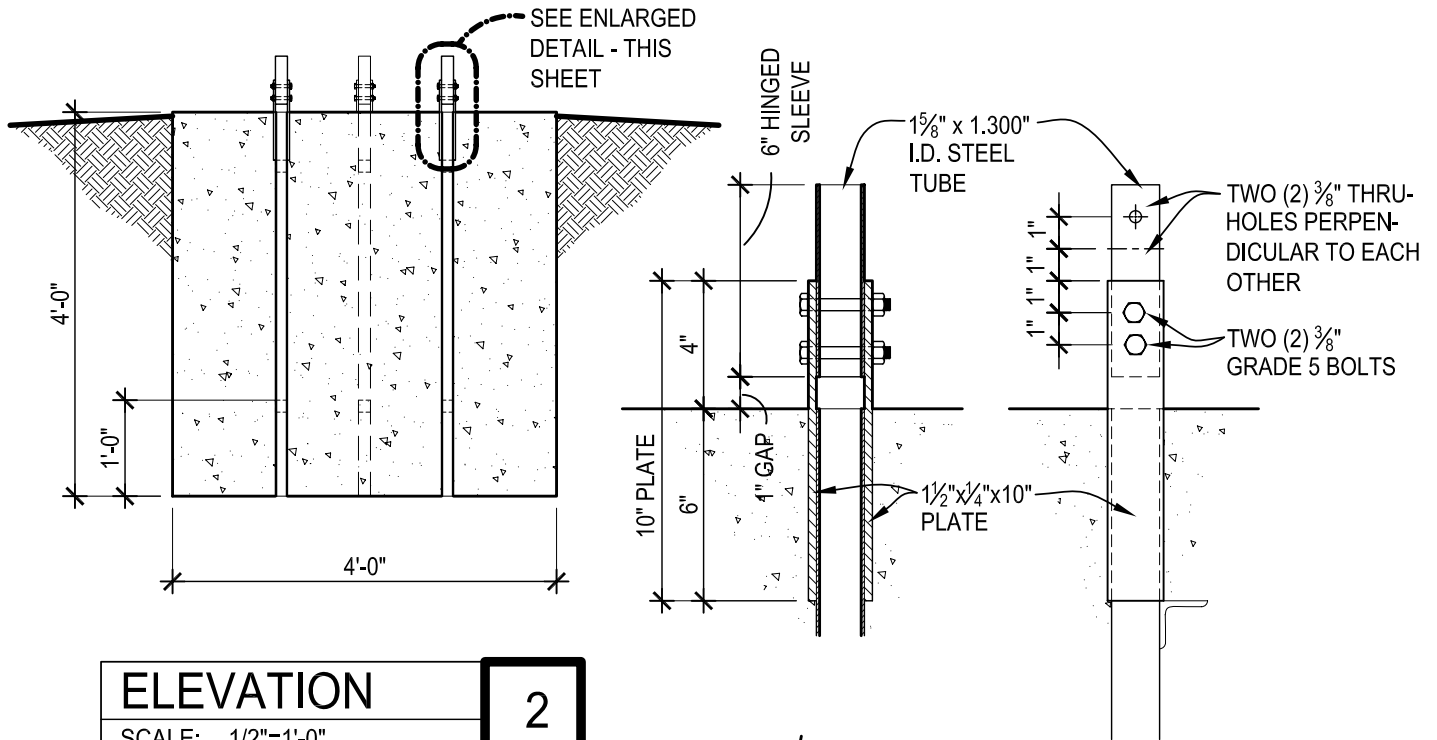

ELEVATION

SCALE: 1/2"=1'-0"

2

NOTE: FOUNDATIONS ARE DESIGNED FOR FIRM BEARING SOIL.

BASE FOOTING



UNIVERSAL TOWERS
 A DIVISION OF
 UNIVERSAL MANUFACTURING CORP.
 43900 GROESBECK HWY.
 CLINTON TOWNSHIP, MI 48036
 PH: (586) 463-2560
 FAX: (586) 463-2964

JOB NO.:

COMPONENT:

B-22